

# w17e/W17q LCD Monitor

## User's Guide

- [Preface](#)
  - [Safety and Maintenance Guidelines](#)
  - [Setup](#)
  - [Using the Monitor](#)
  - [Installing Drivers and Using the Auto-Adjustment Feature](#)
  - [Technical Support FAQs](#)
  - [Specifications](#)
  - [LCD Monitor Quality and Pixel Policy](#)
  - [Agency Regulatory Notices](#)
- 

The only warranties for HP products and services are set forth in the express warranty statements accompanying such products and services. Nothing herein should be construed as constituting an additional warranty. HP shall not be liable for technical or editorial errors or omissions contained herein.

HP assumes no responsibility for the use or reliability of its software on equipment that is not furnished by HP.

This document contains proprietary information that is protected by copyright. No part of this document may be photocopied, reproduced, or translated to another language without the prior written consent of HP.

Hewlett-Packard Company  
P.O. Box 4010  
Cupertino, CA 95015-4010  
USA

Copyright © 2007 Hewlett-Packard Development Company, L.P.

Microsoft and Windows are U.S. registered trademarks of Microsoft Corporation.

Adobe and Acrobat are trademarks of Adobe Systems Incorporated.

Bluetooth is a trademark owned by its proprietor and used by Hewlett-Packard Company under license.

HP supports lawful use of technology and does not endorse or encourage the use of its products for purposes other than those permitted by copyright law.

The information in this document is subject to change without notice.

Part number: 446747-002

---

[Back to Contents Page](#)

## Preface

[About This Guide](#) • [Notational Conventions](#)

---

### About This Guide

This guide is intended for anyone who uses the w17e / W17q LCD Monitor. It describes the monitor's features, setup, and operation.

The sections are as follows:

- [Safety and Maintenance Guidelines](#)
- [Setup](#)
- [Using the Monitor](#)
- [Installing Drivers and Using the Auto-Adjustment Feature](#)
- [Technical Support FAQs](#)
- [Specifications](#)
- [LCD Monitor Quality and Pixel Policy](#)
- [Agency Regulatory Notices](#)

### Notational Conventions

The following subsections describe notational conventions used in this document.

### Notes, Cautions, and Warnings

Throughout this guide, blocks of text may be accompanied by an icon and printed in bold type or in italic type. These blocks are notes, cautions, and warnings, and they are used as follows:



**NOTE:** A NOTE indicates important information that helps you make better use of your monitor.

---



**CAUTION:** A CAUTION indicates either potential damage to hardware or loss of data, and tells you how to avoid the problem.

---



**WARNING:** A WARNING indicates the potential for bodily harm and tells you how to avoid the problem.

---

Some warnings may appear in alternate formats and may be unaccompanied by an icon. In such cases, the specific presentation of the warning is mandated by regulatory authority.

## Safety and Maintenance Guidelines

[Important Safety Information](#) • [Safety Precautions](#) • [Maintenance Guidelines](#) • [Cleaning the Monitor](#)

---

### Important Safety Information

The power cord is designed for use with your monitor. To use a different cord, use only a power source and connection compatible with this monitor. For information on the correct power cord set to use with your monitor, see [Power Cord Set Requirements](#).



**WARNING:** To reduce the risk of electric shock or damage to your equipment, do not disable the power cord grounding feature. The grounding plug is an important safety feature. Connect the equipment to a grounded (earthed) power outlet.

---



**WARNING:** For your safety, be sure that the grounded power outlet you plug the power cord into is easily accessible to the operator and located as close to the equipment as possible. To disconnect power from the equipment, unplug the power cord from the power outlet by grasping the plug firmly. Never pull on the cord.

---



**CAUTION:** To protect your monitor, as well as your computer, connect all power cords for your computer and its peripheral devices (such as a monitor, printer, or scanner) to a surge protection device such as a power strip with surge protection or uninterruptible power supply (UPS).

**Not all power strips provide surge protection; the power strips must be specifically labeled as having this ability. Use a power strip whose manufacturer offers a damage replacement policy so you can replace your equipment if surge protection fails.**

---

### Safety Precautions



**CAUTION:** Avoid applying pressure to the LCD screen; doing so can cause damage.

---

- Use only a power source and connection compatible with this monitor, as indicated on the label/back plate of the monitor.
- Be sure the total ampere rating of the products connected to the outlet does not exceed the current rating of the electrical outlet, and the total ampere rating of the products connected to the cord does not exceed the rating of the cord. Look on the power label to determine the ampere rating (Amps or A) for each device.
- Install your monitor near an outlet that you can easily reach. Disconnect the monitor by grasping the plug firmly and pulling it from the outlet. Never disconnect the monitor by pulling the cord.
- Do not allow anything to rest on the power cord. Do not walk on the cord.

## Maintenance Guidelines

To enhance the performance and extend the life of your monitor:

- Do not open your monitor cabinet or attempt to service this product yourself. If your monitor is not operating properly or has been dropped or damaged, contact your Hewlett-Packard authorized dealer, reseller, or service provider.
- Adjust only those controls that are described in the operating instructions.
- Turn your monitor off when not in use. You can substantially increase the life expectancy of your monitor by using a screen saver and turning off the monitor when not in use.
- Keep your monitor in a well-ventilated area, away from excessive light, heat, or moisture.
- Slots and openings in the cabinet are provided for ventilation. These openings must not be blocked or covered. Never push objects of any kind into cabinet slots or other openings.
- Unplug your monitor from the wall outlet before cleaning.
- Do not drop your monitor or place it on an unstable surface.
- When removing the monitor pedestal base, you must lay the monitor face down on a soft area to prevent it from getting scratched, defaced, or broken.

## Cleaning the Monitor

The monitor is a high-quality optical device that requires special care when cleaning. To clean the monitor, follow these steps:

- 1 Turn off the computer and the monitor.
- 2 Unplug your monitor from the wall outlet before cleaning.



**CAUTION: Do not use benzene, thinner, ammonia, or any volatile substances to clean the monitor screen or cabinet. These chemicals may damage the monitor. Do not use liquid cleaners or aerosol cleaners. Never use water to clean an LCD screen.**

---

- 3 Wipe the screen with a dry, soft, clean cloth.  
If the screen requires additional cleaning, use an antistatic screen cleaner.
- 4 Dust the monitor housing. Use a damp cloth to clean the cabinet.  
If the cabinet requires additional cleaning, use a clean cloth dampened with isopropyl alcohol.
- 5 Plug in the monitor.
- 6 Turn on the monitor and the computer.

---

[Back to Contents Page](#)

## Setup

[Base and Tilt](#) • [Cables](#) • [Wall Mounting Arm](#)

### Base and Tilt

[Attaching the Base](#) • [Removing the Base](#) • [Adjusting the Tilt](#)

---

#### Attaching the Base

- 1 Set the panel face-down on a flat, protected surface.
- 2 Align the pedestal slots with the panel tabs and insert **(A)**.
- 3 Slide the pedestal to the right to lock it into place **(B)**.
- 4 Lift the panel and lower the pedestal onto the base until the push tab locks.

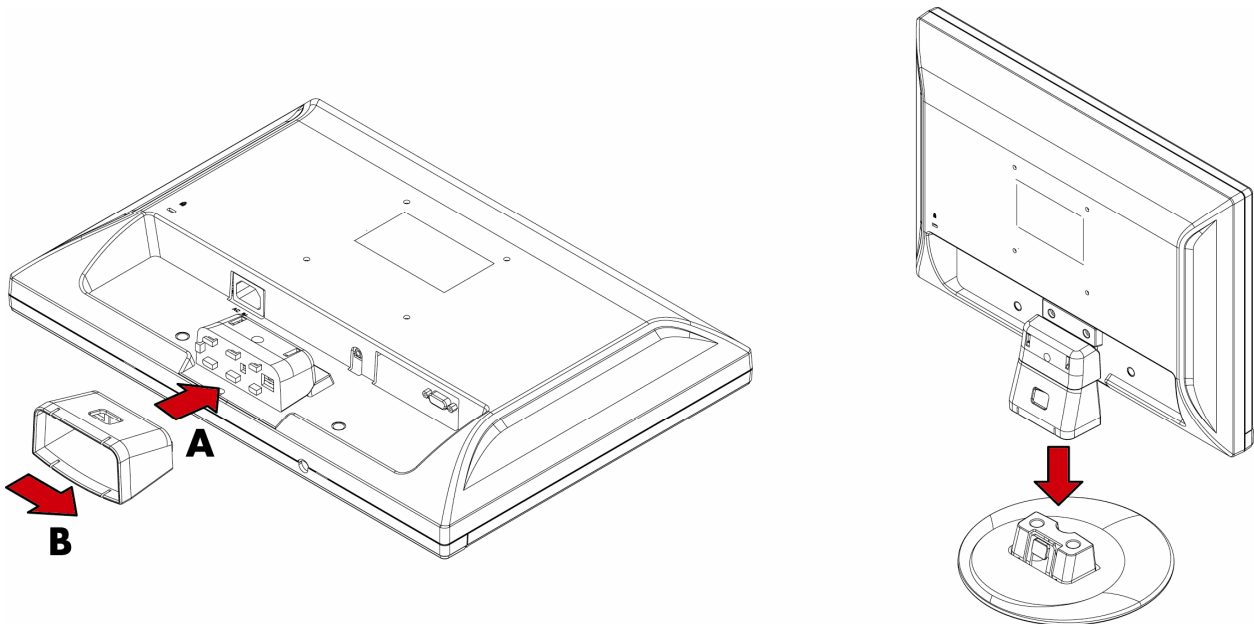

**WARNING:** Be careful to avoid pinching or scraping fingers when attaching the base.



**CAUTION:** To prevent damage, avoid applying pressure to the panel front.

---

## Removing the Base

- 1 Push the release tab and raise the pedestal off the base.

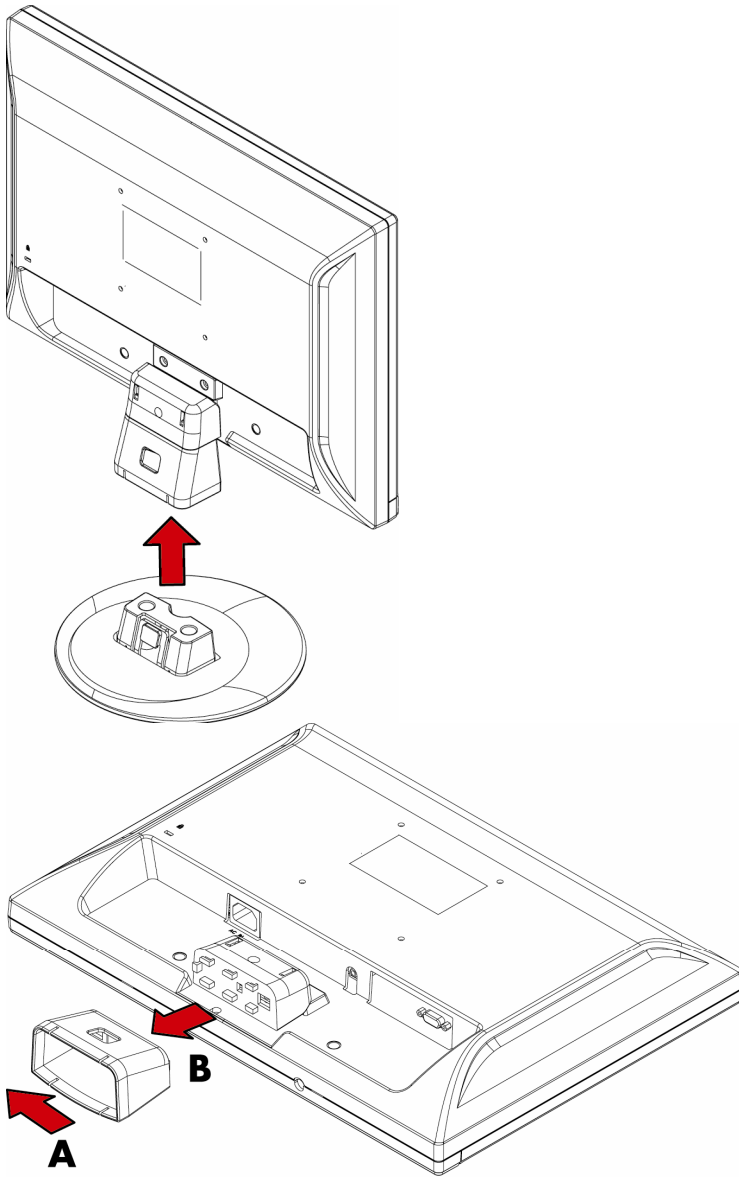

- 2 Set the panel face-down on a flat, protected surface.
- 3 Slide the pedestal to the left to unlock it from the base (A).
- 4 Remove the pedestal from the panel (B).



**WARNING: Be careful to avoid pinching or scraping fingers when attaching the base.**



**CAUTION: To prevent damage, avoid applying pressure to the panel front.**

---

## Adjusting the Tilt

For optimal viewing, adjust the screen tilt to your own preference, as follows:

- 1 Face the front of the monitor and hold the stand so that you do not topple the monitor while changing the tilt.
- 2 Adjust the tilt by moving the monitor's top edge toward or away from you.

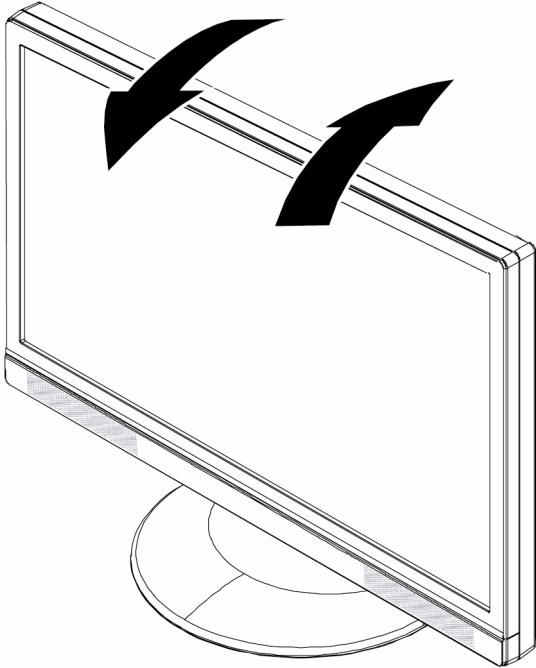

**CAUTION: To avoid breakage or other damage, do not touch the LCD screen while changing the tilt.**

---

## Cables

### [Attaching the Cables](#)

---

#### Attaching the Cables

Attach the provided VGA cable to this monitor. Connectors are on the back of the monitor.

- 1 Turn off your computer.
- 2 Connect the built-in monitor speakers to the computer, using the audio cable (green connector).

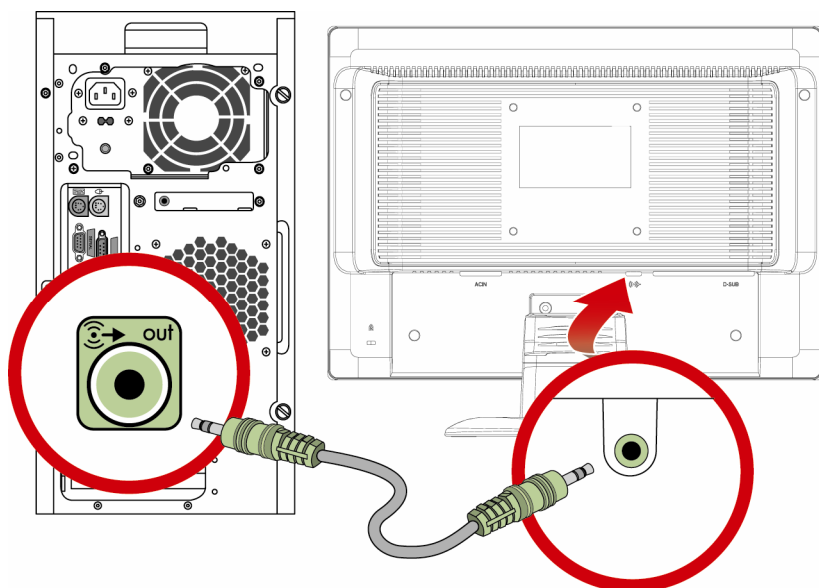



- 3** Connect one end of the 15-pin D-Sub VGA cable (blue connector) to the back of the monitor and connect the other end to the computer VGA port.

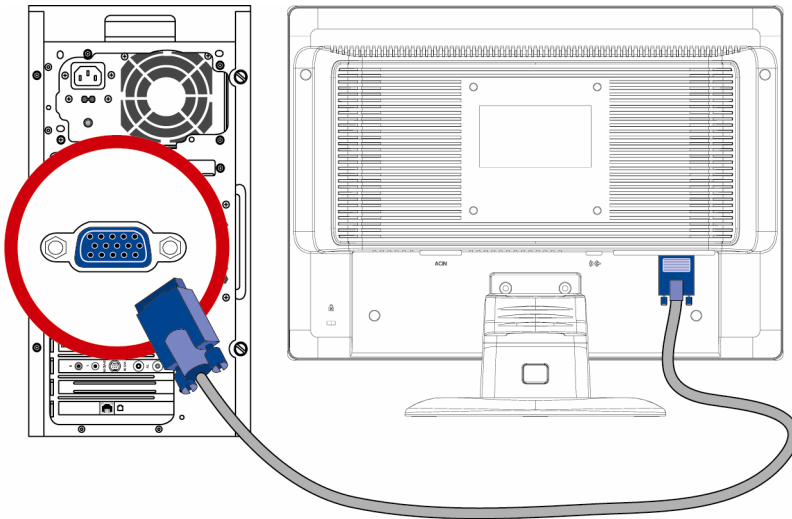

- 4** Connect one end of the power cord to the back of the monitor and plug the other end into a grounded outlet.

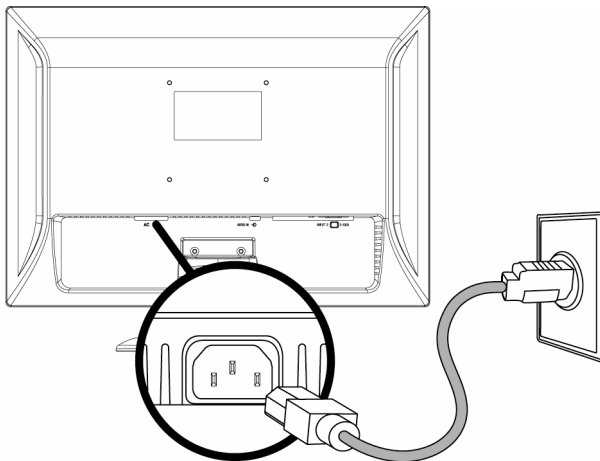

- 5** Turn on your monitor and computer.

If your monitor displays an image, installation is complete. If it does not display an image, see [Technical Support FAQs](#) and [Using the Monitor](#).

---

[Back to Contents Page](#)

## Wall Mounting Arm

[Preparing to Install a Wall Mounting Arm \(Not supplied\)](#) • [Installing a Wall Mounting Arm](#)

---

### Preparing to Install a Wall Mounting Arm (Not supplied)

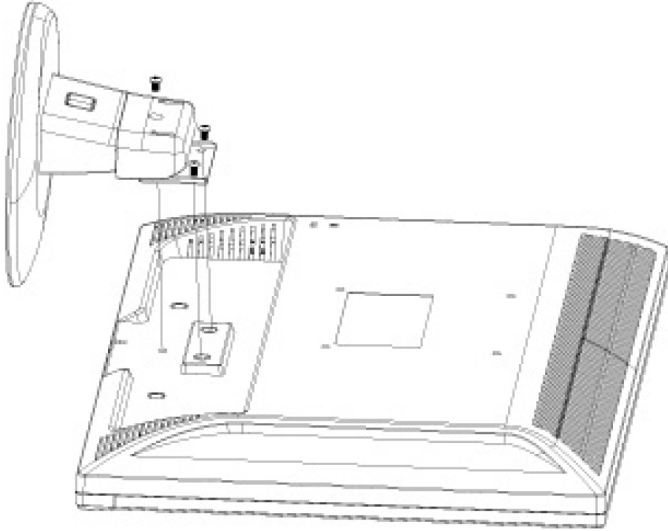

This monitor can be attached to a wall mounting arm that you purchase separately.



**CAUTION:** Before disassembling the monitor, turn off the monitor power, and disconnect all power, video, and audio cables.

---

- 1 Disconnect the cables from the monitor.
- 2 With the panel face-down on a protected surface, remove the screws and the pedestal attachment.
- 3 Follow the manufacturer's instructions to assemble the wall mounting arm.

See [Installing a Wall Mounting Arm](#) for further installation instructions.

### Installing a Wall Mounting Arm

- 1 Set the monitor screen down on a flat, soft, protected surface.
- 2 Place the wall mounting arm onto the back of the monitor. Line up the holes of the arm with the mounting holes in the back of the monitor.
- 3 Insert four screws into the mounting holes and tighten.
- 4 Reconnect the cables. Refer to the user's manual that came with the wall mounting arm (purchased separately) for instructions on attaching it to the wall.

---

[Back to Contents Page](#)

## Using the Monitor

[Operating Instructions](#) • [External Controls](#) • [LED Indicators](#) • [Settings](#) • [Setting the Optimal Resolution](#) • [Adjusting the Volume](#) • [Locking the OSD](#) • [Adjusting OSD Settings](#) • [OSD Menu](#)

---

## Operating Instructions

Control buttons are located on the front of the panel, as shown in the illustration following. Use the Menu button to adjust the display settings to your personal preferences:

- Set up the monitor, attach the cables, and adjust the tilt as described in the [Setup](#) section above.
- Press the power button to turn the monitor on and off. The power indicator lights up when the monitor is on.
- The monitor must be turned on for the other control buttons to work.
- Set the resolution ([Setting the Optimal Resolution](#)) and adjust the volume ([Adjusting the Volume](#)).
- Adjust the onscreen display (OSD) settings ([Adjusting OSD Settings](#)).

## External Controls

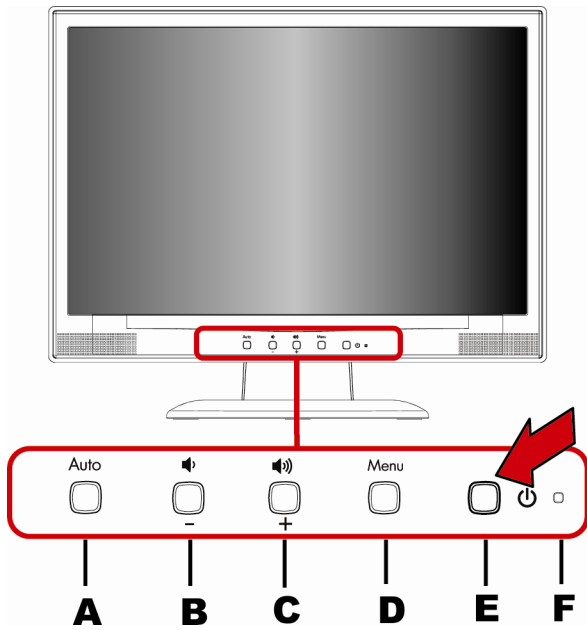

- A** Auto-configuration / Exit
- B** Volume decrease / Left navigation
- C** Volume increase / Right navigation
- D** Menu / Enter
- E** Power
- F** LED indicator

## LED Indicators

Status	LED Color
Full Power Mode	Green
Power Save Mode	Amber

See [Technical Support FAQs](#) for more information.

---

[Back to Contents Page](#)

## Settings

[Setting the Optimal Resolution](#) • [Adjusting the Volume](#) • [Locking the OSD](#) • [Adjusting OSD Settings](#) • [OSD Menu](#)

---

### Setting the Optimal Resolution

The recommended resolution for this monitor is 1440 by 900. To configure the monitor to this resolution, complete the setup procedure and make sure that the monitor is connected to the computer. Turn the monitor on and do the following:

- 1 Click the **Windows Start Button** , and then click **Control Panel**.
- 2 Under **Appearance and Personalization**, click **Adjust Screen Resolution**.
- 3 Set the resolution **slide bar** to 1440 by 900.



**NOTE:** If 1440 by 900 is not shown, download the monitor driver from the Web. See [Using the Monitor](#) for instructions.

---

### Adjusting the Volume

Press the front monitor panel volume increase and decrease buttons to adjust volume to the desired level. Volume can range from 0 (mute) to 100. The preset value is 50. Volume cannot be adjusted through the OSD menu.

### Locking the OSD

To lock the OSD (onscreen display), press and hold the Menu button while the monitor is off, then press the power button to turn the monitor on. To unlock the OSD, repeat the locking procedure. When the OSD is locked, settings cannot be changed in the OSD menu.

## Adjusting OSD Settings





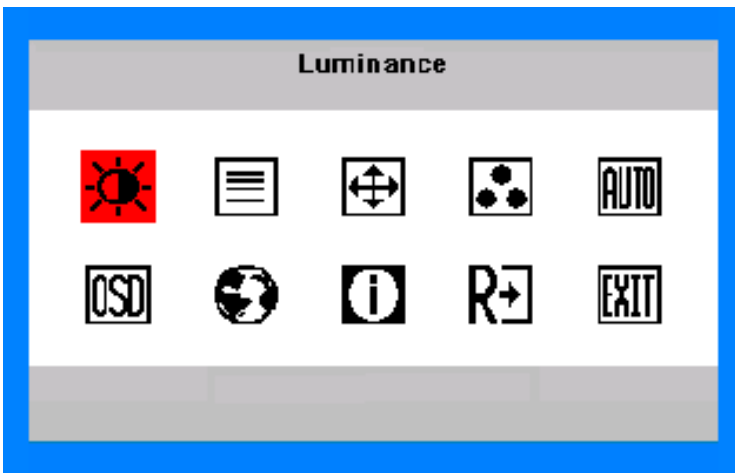

- 1 Press the Menu button to activate the OSD menu.
- 2 Press + or – on the monitor front panel to navigate through the functions. Once the desired function is highlighted, press the Menu button again to activate it. If the selected function has a sub-menu, it will be displayed. Press + or – again to navigate through the sub-menu functions. Once the desired sub-function is highlighted, press the Menu button to activate it.
- 3 Press + or – to change the settings of the selected function.
- 4 To exit and save, select the **Exit** function. If you want to adjust another function, repeat steps 2–3.













## OSD Menu

The figure below shows the OSD menu that appears when you first press the Menu button. In this figure, the Luminance icon has been selected, so it is highlighted and its title is displayed. Pressing Menu again will display the sub-menu for this function.



### Main Menu and Sub-Menu Items for Adjusting the OSD

Main Menu Item	Main Menu Icon	Sub-Menu Item	Sub-Menu Icon	Description
Luminance		Contrast		Contrast from digital-register
		Brightness		Backlight adjustment
Image Setup		Focus		Adjust picture phase to reduce horizontal-line noise
		Clock		Adjust picture clock to reduce vertical-line noise

Main Menu Item	Main Menu Icon	Sub-Menu Item	Sub-Menu Icon	Description ( <i>continued</i> )
Image Position		H. Position		Adjust the horizontal position of the picture
		V. Position		Adjust the vertical position of the picture
Color Temp.		Warm	N/A	Recall warm color temperature from EEPROM
		Cool	N/A	Recall cool color temperature from EEPROM
		sRGB	N/A	Recall sRGB temperature from EEPROM
		User / Red	<b>R</b>	Red gain from digital-register
		User / Green	<b>G</b>	Green gain from digital-register
		User / Blue	<b>B</b>	Blue gain from digital-register
Auto-adjustment				Automatically adjust the screen display for optimal viewing
OSD Setup		H. Position		Adjust the horizontal position of the OSD
		V. Position		Adjust the vertical position of the OSD
		OSD Timeout		Adjust the OSD timeout
Language		Language	N/A	Select the language you like
Information		Information	N/A	Show the resolution, H/V frequency and input port of current input timing
Reset		Yes	N/A	Clear each old status of auto-configuration
		No	N/A	Do not execute reset, return to main menu
Exit		N/A	N/A	Exit OSD

See [Specifications](#) for the horizontal and vertical scan ranges addressable by this monitor.

---

[Back to Contents Page](#)

# Installing Drivers and Using the Auto-Adjustment Feature

[Downloading Drivers and Software](#) • [Using the Auto-Adjustment Function](#)

---

## Downloading Drivers and Software

To download the latest version of drivers and software files from the HP Support Web site:

- 1** Refer to: <http://www.hp.com/support>
- 2** Select your country/region.
- 3** Select **Download Drivers and Software**.
- 4** Enter the model number of your monitor. The software download pages for your monitor will be displayed.
- 5** Download and install the driver and software files using the instructions in the download pages.

## Using the Auto-Adjustment Function

Press the Auto button to optimize the screen performance for VGA (analog). You can also access the Auto-adjustment feature through the OSD menu.

Auto-adjustment can correct the following image quality conditions:

- Fuzzy or unclear focus
- Ghosting, streaking, or shadowing effects
- Faint vertical bars
- Thin, horizontal scrolling lines
- An off-center picture



---

[Back to Contents Page](#)

## Technical Support FAQs

[Technical Support FAQs \(Frequently Asked Questions\)](#)

---

### Technical Support FAQs (Frequently Asked Questions)

Problem & Question	Possible Solutions
Power LED is not on	<ul style="list-style-type: none"><li>• Make sure the Power button is on and the power cord is properly connected to a grounded power outlet and to the monitor.</li></ul>
No Plug & Play	<ul style="list-style-type: none"><li>• In order for the Plug &amp; Play feature of the monitor to work, you need a Plug &amp; Play compatible computer and video card. Check with your computer manufacturer.</li><li>• Check the monitor's video cable and make sure none of the pins are bent.</li><li>• Make sure the HP monitor drivers are installed (HP monitor drivers are available at: <a href="http://www.hp.com/support">http://www.hp.com/support</a>).</li></ul>
Picture is fuzzy and has ghosting shadowing problem	<ul style="list-style-type: none"><li>• Adjust the contrast and brightness controls.</li><li>• Make sure you are not using an extension cable or switch box. We recommend plugging the monitor directly into the video card output connector on the back of your computer.</li><li>• Adjust the Image Setup feature in the OSD main menu.</li><li>• The Auto-adjustment function may fix this problem.</li></ul>
Picture bounces, flickers or wave pattern is present in the picture	<ul style="list-style-type: none"><li>• Move electrical devices that may cause electrical interference as far away from the monitor as possible.</li><li>• Use the maximum refresh rate your monitor is capable of at the resolution you are using.</li></ul>
Monitor is stuck in "Active Off-Mode"	<ul style="list-style-type: none"><li>• The computer power switch should be in the on position.</li><li>• The computer video card should be snugly seated in its slot.</li><li>• Make sure the monitor's video cable is properly connected to the computer.</li><li>• Inspect the monitor's video cable and make sure none of the pins are bent.</li><li>• Make sure your computer is operational by hitting the Caps Lock key on the keyboard while observing the Caps Lock LED. The LED should either turn on or off after hitting the Caps Lock key.</li></ul>

Problem & Question	Possible Solutions ( <i>continued</i> )
Missing one of the primary colors (red, green, or blue)	<ul style="list-style-type: none"> <li>• Inspect the monitor's video cable and make sure that none of the pins are bent.</li> <li>• Make sure the monitor's video cable is properly connected to the computer.</li> </ul>
Screen image is not centered or sized properly	<ul style="list-style-type: none"> <li>• Adjust horizontal and vertical screen position.</li> <li>• The auto-adjustment function may fix this problem.</li> </ul>
Picture has color defects (white does not look white)	<ul style="list-style-type: none"> <li>• Adjust RGB color or select color temperature.</li> </ul>
Unable to set the monitor to the optimal resolution	<ul style="list-style-type: none"> <li>• Make sure that the graphics card supports the optimal resolution (1440 x 900).</li> <li>• Make sure that the latest supported driver is installed for the graphics card. For HP and Compaq systems, you can download the latest graphics driver for your system from:  <b><a href="http://www.hp.com/support">http://www.hp.com/support</a></b>  For other systems, refer to the Web site for your graphics card.</li> </ul>

---

[Back to Contents Page](#)

## Specifications

[General](#) • [LCD Panel \(17"\)](#) • [Resolution](#) • [Preset Display Modes](#) • [Physical Characteristics](#) • [Environmental](#) • [Power Cord Set Requirements](#) • [VGA Connector Pin Assignments](#) • [Plug and Play DDC2B Feature](#)

---

All specifications represent the typical specifications provided by HP's component manufacturers; actual performance may vary either higher or lower.

### General

Model number	w17e / W17q
--------------	-------------

### LCD Panel (17")

Driving system	TFT Active Matrix Color LCD
Size	431.8 mm (17" diagonal)
Video	R, G, B Analog Interface
Separate sync.	H/V TTL & TMDS
Display color	262,000 colors
Dot clock	135 MHz maximum
Pixel Pitch	0.255 mm (H) x 0.255 mm (V)
Face treatment	Antiglare polarizer with hard coating
Viewable angle	140° (H), 130° (V)

### Resolution

Horizontal scan range	30 kHz to 83 kHz
Horizontal scan size (Maximum)	367.2 mm
Vertical scan range	55 Hz to 75 Hz
Vertical scan size (Maximum)	229.5 mm
Optimal preset resolution	1440 x 900 at 60 Hz
Highest preset resolution	1440 x 900 at 75 Hz
Highest addressable resolution	1440 x 900 at 75 Hz
Plug & Play	VESA DDC2B
Input Connectors	D-Sub VGA 15-pin and audio jack
Input Video Signal	Analog: 0.7Vp-p (standard), 75 OHM
Power Source	100~240V~, 47~63 Hz

## Preset Display Modes

Standard	Resolution	Horizontal Frequency (kHz)	Vertical Frequency (Hz)
Dos-mode	720 x 400	31	70
VGA	640 x 480	31	60
VGA	640 x 480	35	67
VGA	640 x 480	38	73
VGA	640 x 480	38	75
SVGA	800 x 600	35	56
SVGA	800 x 600	38	60
SVGA	800 x 600	48	72
SVGA	800 x 600	47	75
SVGA	832 x 624	50	75
XGA	1024 x 768	48	60
XGA	1024 x 768	56	70
XGA	1024 x 768	60	75
SXGA	1152 x 864	68	75
WXGA	1440 x 900	56	60
WXGA	1440 x 900	71	75

## Physical Characteristics

Connector Types	15-pin Mini D-Sub VGA
Signal Cable Type	Detachable
<b>Dimensions &amp; Weight:</b>	
Height (with base)	13.1 inches (332.4 mm)
Width	15.8 inches (400.4 mm)
Depth	8.3 inches (211 mm)
Weight (monitor only)	7.17 lb (3.25 Kg)
Weight (with packaging)	10.67 lb (4.84 Kg)

## Environmental

<b>Temperature:</b>	
Operating	5°C to +35°C
Non-Operating	-20°C to +60°C
<b>Humidity:</b>	
Operating	20% to 80% (non-condensing)
Non-Operating	5% to 90% (non-condensing)
<b>Altitude:</b>	
Operating	0~3,658 m (0~12,000 ft)
Non-Operating	0~12,192 m (0~40,000 ft)

## Power Cord Set Requirements

The monitor power supply is provided with automatic line switching (ALS). This feature allows the monitor to operate on input voltages in the range of 100–240V $\sqrt{\text{~}}$ , 50/60 Hz, 1.5A.

The power cord set (flexible cord or wall plug) received with the monitor meets the requirements for use in the country/region where the equipment was purchased.

If you need to obtain a power cord for a different country/region, you should purchase a power cord that is approved for use in that country/region.

The power cord must be rated for the product and for the voltage and current marked on the product's electrical ratings label. The voltage and current rating of the cord should be greater than the voltage and current rating marked on the product. In addition, the cross-sectional area of the wire must be a minimum of 0.75 mm<sup>2</sup> (0.03 in<sup>2</sup>) or 18AWG, and the length of the cord must be between 1.5 m (4.94 ft) and 3.6 m (12 ft). If you have questions about the type of power cord to use, contact your HP-authorized service provider.

A power cord should be routed so that it is not likely to be walked on or pinched by items placed upon it or against it. Particular attention should be paid to the plug, electrical outlet, and the point where the cord exits from the product.

## VGA Connector Pin Assignments

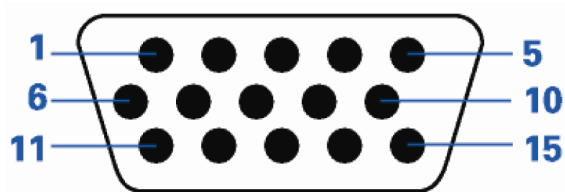

Pin Number	15-Pin Side of the Signal Cable
1	Video-Red
2	Video-Green
3	Video-Blue
4	Ground
5	Detect Cable
6	GND-R
7	GND-G
8	GND-B
9	+5V
10	Ground
11	Ground
12	DDC-Serial data
13	H-sync
14	V-sync
15	DDC-Serial clock

## Plug and Play DDC2B Feature

This monitor is equipped with VESA DDC2B capabilities according to the VESA DDC STANDARD. It allows the monitor to inform the host system of its identity and, depending on the level of DDC used, communicate additional information about its display capabilities.

The DDC2B is a bi-directional data channel based on the I<sup>2</sup>C protocol. The host can request EDID information over the DDC2B channel.

[Back to Contents Page](#)

## LCD Monitor Quality and Pixel Policy

The HP LCD Monitor uses high-precision technology, manufactured according to high standards, to help guarantee trouble-free performance. Nevertheless, the display may have cosmetic imperfections that appear as small bright or dark spots. This is common to all LCD displays used in products supplied by all vendors and is not specific to the HP LCD Monitor. These imperfections are caused by one or more defective pixels or subpixels.

- A pixel consists of one red, one green, and one blue subpixel.
- A defective whole pixel is always turned on (a bright spot on a dark background), or it is always off (a dark spot on a bright background). The first is the more visible of the two.
- A defective subpixel (dot defect) is less visible than a defective whole pixel and is small and only visible on a specific background.

To locate defective pixels, the monitor should be viewed under normal operating conditions and in normal operating mode at a supported resolution and response rate, from a distance of approximately 50 cm (16 in).

We expect that, over time, the industry will continue to improve its ability to produce displays with fewer cosmetic imperfections, and we will adjust guidelines as improvements are made.

For more information about your w17e / W17q LCD Monitor, refer to the HP Web site at:

**<http://www.hp.com/support>**

---

[Back to Contents Page](#)

## Agency Regulatory Notices

[Federal Communications Commission Notice](#) • [Modifications](#) • [Cables](#) • [Declaration of Conformity for Products Marked with FCC Logo, United States Only](#) • [Canadian Notice](#) • [Avis Canadien](#) • [European Union Regulatory Notice](#) • [Disposal of Waste Equipment by Users in Private Households in the European Union](#) • [Japanese Notice](#) • [Japanese Power Cord Notice](#) • [Japanese Material Content Declaration](#) • [Korean Notice](#) • [Materials Disposal](#) • [HP Recycling Program](#) • [EPA ENERGY STAR® Compliance](#)

---

### Federal Communications Commission Notice

This equipment has been tested and found to comply with the limits for a Class B digital device, pursuant to Part 15 of the FCC Rules. These limits are designed to provide reasonable protection against harmful interference in a residential installation. This equipment generates, uses, and can radiate radio frequency energy and, if not installed and used in accordance with the instructions, may cause harmful interference to radio communications. However, there is no guarantee that interference will not occur in a particular installation. If this equipment does cause harmful interference to radio or television reception, which can be determined by turning the equipment off and on, the user is encouraged to try to correct the interference by one or more of the following measures:

- Reorient or relocate the receiving antenna.
- Increase the separation between the equipment and the receiver.
- Connect the equipment into an outlet on a circuit different from that to which the receiver is connected.
- Consult the dealer or an experienced radio or television technician for help.

### Modifications

The FCC requires the user to be notified that any changes or modifications made to this device that are not expressly approved by Hewlett-Packard Company may void the user's authority to operate the equipment.

### Cables

Connections to this device must be made with shielded cables with metallic RFI/EMI connector hoods to maintain compliance with FCC rules and regulations.

## Declaration of Conformity for Products Marked with FCC Logo, United States Only

This device complies with Part 15 of the FCC Rules. Operation is subject to the following two conditions: (1) this device may not cause harmful interference, and (2) this device must accept any interference received, including interference that may cause undesired operation.

For questions regarding your product, contact:

Hewlett-Packard Company  
P. O. Box 692000, Mail Stop 530113  
Houston, Texas 77269-2000

Or

call: 1-(800)-474-6836

For questions regarding this FCC declaration, contact:

Hewlett-Packard Company  
P. O. Box 692000, Mail Stop 510101  
Houston, Texas 77269-2000

Or

call: 1-(281)-514-3333

To identify this product, refer to the part, series, or model number found on the product.

## Canadian Notice

This Class B digital apparatus meets all requirements of the Canadian Interference-Causing Equipment Regulations.

## Avis Canadien

Cet appareil numérique de la classe B respecte toutes les exigences du Règlement sur le matériel brouilleur du Canada.



## European Union Regulatory Notice

This product complies with the following EU directives:

- Low Voltage Directive 2006/95/EC
- EMC Directive 89/336/EEC

Compliance with these directives implies conformity to applicable harmonized European standards (European Norms) which are listed on the EU Declaration of Conformity issued by Hewlett-Packard for this product or product family.

This compliance is indicated by the following conformity marking placed on the product:

 This marking is valid for non-Telecom products and EU harmonized Telecom products (e.g., Bluetooth).	 This marking is valid for EU non-harmonized Telecom products. *Notified body number (used only if applicable — refer to the product label).
---	---

Hewlett-Packard GmbH, HQ-TRE, Herrenberger Strasse 140, 71034 Boeblingen, Germany



## Disposal of Waste Equipment by Users in Private Households in the European Union



This symbol on the product or on its packaging indicates that this product must not be disposed of with your other household waste. Instead, it is your responsibility to dispose of your waste equipment by handing it over to a designated collection point for the recycling of waste electrical and electronic equipment. The separate collection and recycling of your waste equipment at the time of disposal will help to conserve natural resources and ensure that it is recycled in a manner that protects human health and the environment. For more information about where you can drop off your waste equipment for recycling, please contact your local city office, your household waste disposal service or the shop where you purchased the product.

### Japanese Notice

この装置は、情報処理装置等電波障害自主規制協議会（VCCI）の基準に基づくクラスB情報技術装置です。この装置は、家庭環境で使用することを目的としていますが、この装置がラジオやテレビジョン受信機に近接して使用されると、受信障害を引き起こすことがあります。

取扱説明書に従って正しい取り扱いをして下さい。

### Japanese Power Cord Notice

製品には、同梱された電源コードをお使い下さい。  
同梱された電源コードは、他の製品では使用出来ません。

## Japanese Material Content Declaration

A Japanese regulatory requirement, defined by Specification JIS C 0950, 2005, mandates that manufacturers provide Material Content Declarations for certain categories of electronic products offered for sale after July 1, 2006. To view the JIS C 0950 material declaration for this product, visit [www.hp.com/go/jisc0950](http://www.hp.com/go/jisc0950)

2005年、日本における製品含有表示方法、JISC0950が公示されました。製造事業者は、2006年7月1日以降に販売される電気・電子機器の特定化学物質の含有に付きまして情報提供を義務付けられました。製品の部材表示に付きましては、[www.hp.com/go/jisc0950](http://www.hp.com/go/jisc0950) を参照してください。

## Korean Notice

### B급 기기 (가정용 정보통신기기)

이 기기는 가정용으로 전자파적합등록을 한 기기로서  
주거지역에서는 물론 모든지역에서 사용할 수 있습니다.

## Materials Disposal

This HP product contains Mercury in the fluorescent lamp in the display LCD that might require special handling at end-of-life.

Disposal of this material can be regulated because of environmental considerations. For disposal or recycling information, please contact your local authorities or the Electronic Industries Alliance (EIA) ([www.eiae.org](http://www.eiae.org)).

## HP Recycling Program

HP offers product end-of-life return programs for HP and other manufacturers' hardware in several geographic areas.

The terms and availability of these programs vary by geography because of differences in regulatory requirements and local customer demand. For information on the HP recycling program, refer to the HP Web site at: <http://www.hp.com/recycle>

## The Table of Toxic and Hazardous Substances/Elements and their Content

as required by China's  
Management Methods for Controlling Pollution by Electronic Information Products

Part Name	Toxic and Hazardous Substances and Elements					
	Lead (Pb)	Mercury (Hg)	Cadmium (Cd)	Hexavalent Chromium (Cr(VI))	Polybrominated biphenyls (PBB)	Polybrominated diphenyl ethers (PBDE)
Liquid Crystal Display Panel	X	X	O	O	O	O
Chassis/Other	X	O	O	O	O	O

O: Indicates that this toxic or hazardous substance contained in all of the homogeneous materials for this part is below the limit requirement in SJ/T11363-2006.

X: Indicates that this toxic or hazardous substance contained in at least one of the homogeneous materials used for this part is above the limit requirement in SJ/T11363-2006.

All parts named in this table with an "X" are in compliance with the European Union's RoHS Legislation – "Directive 2002/95/EC of the European Parliament and of the Council of 27 January 2003 on the restriction of the use of certain hazardous substances in electrical and electronic equipment".

Note: The referenced Environmental Protection Use Period Marking was determined according to normal operating use conditions of the product such as temperature and humidity.

## 产品中有毒有害物质或元素的名称及含量 根据中国《电子信息产品污染控制管理办法》

部件名称	有毒有害物质或元素					
	铅 (Pb)	汞 (Hg)	镉 (Cd)	六价铬 (Cr(VI))	多溴联苯 (PBB)	多溴二苯醚 (PBDE)
液晶显示屏	X	X	O	O	O	O
机箱/其他	X	O	O	O	O	O

O: 表示该有毒有害物质在该部件所有均质材料中的含量均在SJ/T11363-2006 标准规定的限量要求以下。

X: 表示该有毒有害物质至少在该部件的某一均质材料中的含量超出SJ/T11363-2006 标准规定的限量要求。

表中标有 "X" 的所有部件都符合欧盟 RoHS 法规

"欧洲议会和欧盟理事会 2003 年 1 月 27 日关于电子电器设备中限制使用某些有害物质的 2002/95/EC 号指令"

注: 环保使用期限的参考标识取决于产品正常工作的温度和湿度等条件

## **EPA ENERGY STAR® Compliance**



Products marked with the ENERGY STAR® logo on the packaging box qualify with the U.S. Environmental Protection Agency's ENERGY STAR® guidelines for energy efficiency.

Products with the ENERGY STAR® label are designed to use less energy, help you save money on utility bills, and help protect the environment.

ENERGY STAR® is a registered trademark owned by the U.S. government.